



RENAULT  
PRO+

Always delivers

# Renault MASTER

Van and Cab Chassis



'Master stacks up well on  
just about every front.'

[motoring.com.au](http://motoring.com.au)



Overseas model shown





# The right choice for your business.

The ability to make the right decisions, the ones that give the best outcomes for the least risk, is what separates successful business owners from the rest. That's what makes the Renault Master range an easy choice.

It features class leading safety technology as standard, a comfortable and feature packed cabin, and comes backed with the security of long warranties. Plus with 12 month service interval's and a capped price service plan, the Master Van and Master Cab Chassis delivers real value to your bottom line.

Available in five body sizes and three body styles, in both front and rear wheel drive configurations, you'll have no trouble finding one to suit your business.

# Your office on the road.



Overseas model shown

Open the driver's door and you'll find a spacious and functional cabin that's made to measure for commercial vehicle drivers. The dash includes plenty of handy storage, and the passenger bench features a fold down centre seat with an integrated table that's made for a lap-top or lunch.

There's an overhead storage shelf for your paperwork and optional under seat storage with 90L of space that's perfect for a lunch cooler or valuable items you'd prefer not to leave out on display.



# Technology designed for you.



The Master range is full of technology designed to make your life easier every day. Like the 'wide-view' blind spot rear view mirror, located on the passenger sun visor, to give the driver extra awareness of their surroundings.

Featuring standard equipment including Cruise Control, multifunction trip computer, audio streaming Bluetooth®, CD/MP3 radio with steering mounted controls, 2 USB audio inputs and a 12V auxiliary power outlet, the Master Van has everything you need.

A wide variety of factory options are also available including hands-free key and the Renault MediaNav Enhanced Navigation system that allows control of all phone, audio and navigation services through a single intuitive and intelligent touchscreen interface.

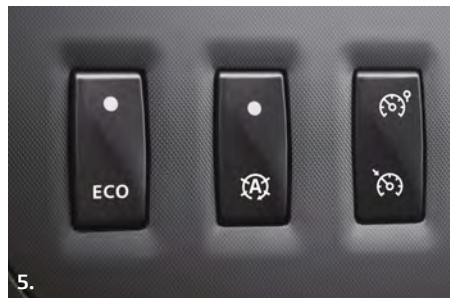

**1. USB port<sup>^</sup>.** Incorporated into the dashboard to keep your mobile charged while you are working.

**2. Optional Fog lamps.** They improve visibility in the event of fog or rain. **3. Extended Grip.** Extended Grip is a traction aid to help you in difficult driving conditions (sand, mud, snow). **4. CD/MP3 radio.** To combine practicality and pleasure, the radio system lets you enjoy an even more user friendly radio with incorporated CD/MP3 player, Bluetooth®, USB port and steering wheel audio controls.

**5. Eco-mode\* and Stop & Start\*.** The eco-mode, which can be activated at the push of a button, helps to reduce consumption and CO2 emissions. With Stop & Start, the engine cuts out automatically when you stop and then slips back into gear and starts again smoothly. **6. Cruise control/speed limiter.** It lets you select a constant speed (regulator function) or set a maximum speed (limiter function).

**7. Manual heating and air-conditioning.** **8. Regulated air-conditioning.\*\*** (Option). Adjustment of the desired temperature and electronic displays and rapid demisting. **9. 3-button key.** It can be used to open/close the opening panels remotely, choosing either the front or rear zones. **10. Optional Key with hands-free access.** Simply carry the hands-free access badge on you. The doors are opened by simply pushing the door handle without using the key.

\* Manual transmission only. \*\* Only available with automatic headlights, windscreen wipers and fog lights)  
<sup>^</sup> (dashboard port N/a with optional MediaNav) With MediaNav, only port available is on radio (MediaNav) unit.



Overseas model shown



## Choose the van to suit your cargo.

Courier, tradie or just about anything in between – there's a Renault Master that's right for you.

With a van range that spans 8 to 17 cubic metres, and payloads from 1.6 to 2.2 tonnes, you'll find a Master Van that's the right size for your business. Choose front wheel drive for a low floor height, easy driveability and plenty of headroom. Or rear wheel drive for high payloads, increased traction and serious cargo carrying capability.

[BOOK A TEST DRIVE >](#)

[FIND A DEALER >](#)

# When the going gets tough, get Master Cab Chassis.



## **Award winning performance.**

Already recognised for its outstanding drivability, practicality and efficiency by winning Delivery Magazine's 2014 Light Truck of the Year, the Master Cab Chassis comes in both 3-seat single and 7-seat dual-cab variants. Both ride on a 4.3m wheelbase, and offer payloads of up to 2.5 tonnes (4.5 tonne GVM).

## **The power to do more.**

Power comes from the same dependable and economical M9T power plant as used in the van models, now mounted longitudinally and driving a ZF 6-speed manual.

## **Customise Master Cab Chassis for your business.**

Rounding out the cab-chassis range is the innovative Platform Cab. Unique in Australia and designed specifically for applications that require a very low rear floor height, the 3.5T FWD Platform Cab is ideal for a wide range of customised bodies, including food vans, mobile offices, furniture vans, animal transport trucks, motor homes and more.

# Power and efficiency.

Just because it's a commercial van, it doesn't mean performance isn't still our first priority. We believe the van you drive for work should be as enjoyable as any other vehicle. With a 110kW turbo (AMT transmission) or 120kW twin-turbo (manual transmission) engine, you'll find both have plenty of grunt for high speed cruising and safe overtaking. Even more impressive, the 360Nm of torque on tap on a manual transmission from a low 1,500rpm's makes for effortless starts and minimal gear changes.

Master Van's power and drivability is delivered with no compromise to economy. Combining twin-turbo technology with Stop/Start, ECO Mode and Renault's Energy Smart Management (a system that uses the vehicles kinetic energy to charge the battery while braking) the 'Energy Dci 165' engine is one of the most efficient large van power plants available. It's also one of the cleanest, reflecting Renault's long standing commitment to reducing our impact on the environment.

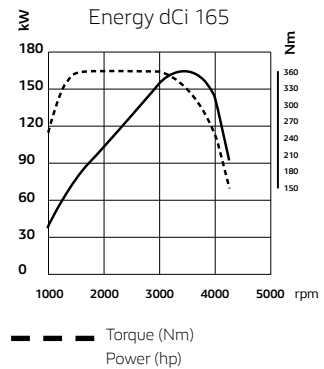

# Front or rear-wheel drive?

In front-wheel drive models the engine is turning less than 2,000rpm's at freeway speeds, delivering excellent fuel economy, with notably low vibration and cabin noise. Good for your sanity, and good for your wallet too.

Rear-wheel drive models feature lower gearing for even more torque, especially at low speeds. With the extra traction from their dual rear wheels, it's just what you need to get your 2.2 tonne payloads moving, no matter what the road surface.

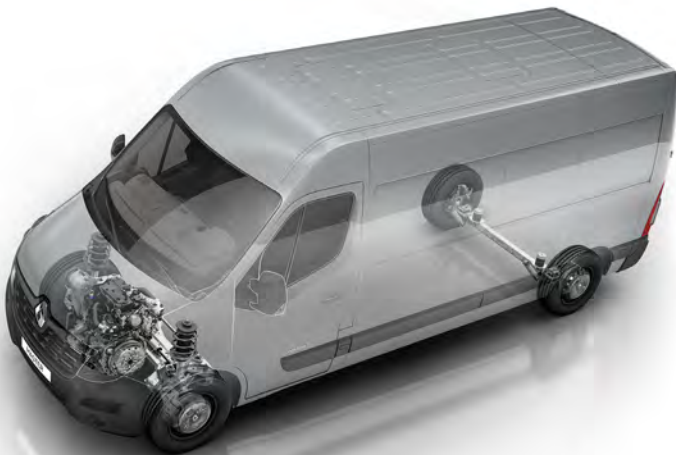

## **Master Van front-wheel drive**

Excellent driving comfort and fuel economy.

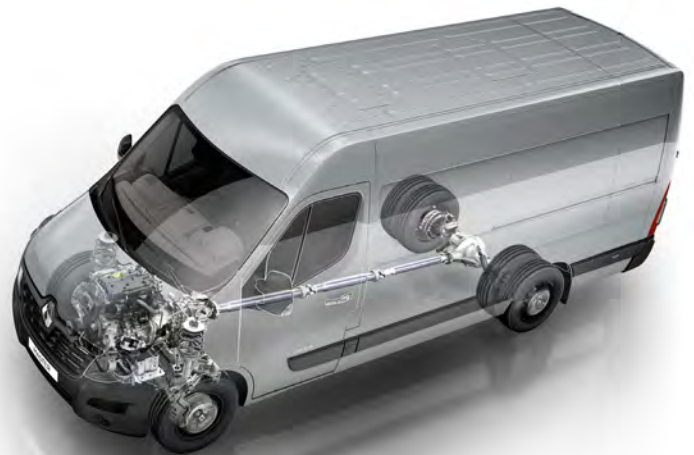

## **Master Van rear-wheel drive**

Capable of bearing heavy loads thanks to improved traction.

# Handle ample payloads.

Available in 4 lengths and 3 heights, Master Van offers an effective volume of between 8m<sup>3</sup> and 17m<sup>3</sup>, with an effective load of up to 2,207kg (on rear-wheel drive version).



L2H2 front-wheel drive (10.8m<sup>3</sup>).



L2 front-wheel drive.

## Master Van.

Full height and width rear barn doors make loading quick and easy. On all except SWB models the doors can be unlatched and folded flat along the van sides for even better access.

## Well adapted.

With an effective loading length of between 2.58m and 3.73m, the Master Van front-wheel drive can hold between 8m<sup>3</sup> and 13m<sup>3</sup> depending on the loading height and length.



Overseas model shown

**Easy versatility.**

Large rear barn doors and your choice of LH (standard) or dual sliding side doors make loading easy from any angle. FWD variants have a handy 1300mm between the wheel arches, so it'll take an Aussie pallet with ease.

# Safety is our priority.

Every Master Van comes with a comprehensive array of passive and active safety features. Up front, the driver gets a 3-point height adjustable seat belt with pre-tensioner, with the added security of standard driver's front and side airbags. The ergonomically designed cockpit helps to limit driver distraction, and fully adjustable seating reduces driver fatigue.

There's a unitary chassis constructed of high strength-to-weight steel for an optimised body that's both lightweight and strong. The engine and transmission are designed to break away downwards in a heavy frontal impact, protecting the occupant's legs and lower body.

**Electronic Stability Control (ESC)**, a sophisticated driver aid that senses loss of traction and then applies the brakes and/or reduces power to these wheels to keep your Master Van on track.

**Roll Over Mitigation (ROM)** applies targeted wheel braking when sensors detect the vehicle is turning too quickly and may be at risk of tipping due to its higher gravitation point.

**Grip X-Tend** maximises grip in slippery conditions or on loose surfaces. Combined with **Traction Control** and **Hill Start Assist**, all these safety features are designed to keep your Master Van under maximum control in all conditions.



### Serious stopping power.

The Master Van's **Anti-lock Braking System (ABS)** means you'll be able to stop in the shortest distance possible, while maintaining full steering control.

With its four wheel discs and **Electronic Brake force Distribution (EBD)**, the Master Van can come to a complete stop from 100km/h in less than 45 metres.

Whether you're the driver or the owner, everyone should come home safe from work. That's why Master Van works hard to keep you out of trouble.

### Sensing your surroundings.

There's an unrivalled view through the large windshield and extensively glazed side doors.

Large side mirrors, a rear camera, park sensors and the innovative Wide View Mirror make for excellent all-round visibility, even in the huge Extended Long Wheelbase model.

A glazed bulkhead helps keep your load in the back, right where it's meant to be.

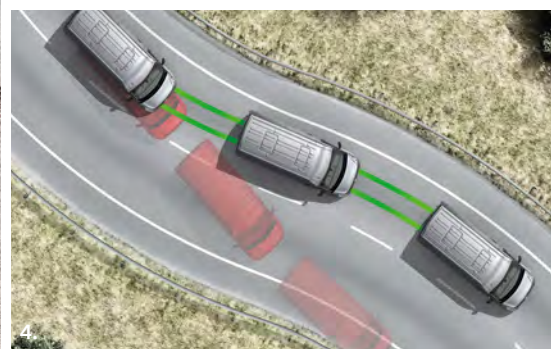
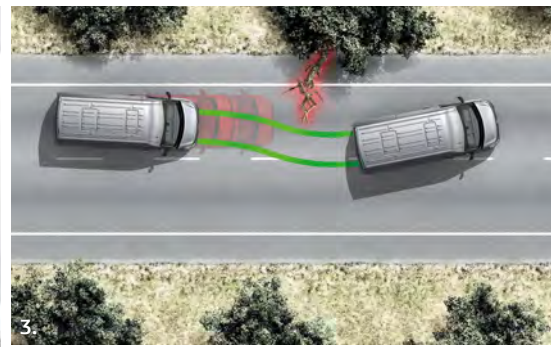

1. Driver and passenger airbags
2. Rear parking sensors and camera
3. ABS with EBD
4. Adaptive ESC and Traction Control
5. Cruise control and speed limiter
6. Cornering lights\*
7. Lane Departure Warning\*

\*Optional equipment

# Colours



Glacier White (389) S



Pearlescent Black (676) M



Orange (031) S



Star Grey (KNH) M

# Technical Specifications

## RENAULT MASTER VAN

| MODEL   | SWB Low Roof                                       |            | MWB Mid Roof        |            | LWB Mid Roof        |            | LWB Mid Roof Window Van | LWB Mid Roof        |                     | ELWB High Roof |            |  |
|---|--|------------|---------------------|------------|---------------------|------------|-------------------------|---------------------|---------------------|----------------|------------|--|
|   | L1H1 FWD   |            | L2H2 FWD            |            | L3H2 FWD            |            |                         | L3H2                |                     | L4H3 RWD       |            |  |
| Transmission                                    | 165 MT   | 150 AMT    | 165 MT              | 150 AMT    | 165 MT              | 150 AMT    | 150 AMT                 | 165 MT              | 150                 | 165 MT         | 150        |  |
| <b>ENGINE</b>                                   |  |            |                     |            |                     |            |                         |                     |                     |                |            |  |
| Type  | Turbocharged & Intercooled Direct Injection Diesel |            |                     |            |                     |            |                         |                     |                     |                |            |  |
| Emission Standard                               | Euro 5   |            |                     |            |                     |            |                         |                     |                     |                |            |  |
| Capacity (cc)                                   | 2,299  |            |                     |            |                     |            |                         |                     |                     |                |            |  |
| Bore x Stroke                                   | 85 x 101.3   |            |                     |            |                     |            |                         |                     |                     |                |            |  |
| Cylinders / Valves                              | 4 / 16   |            |                     |            |                     |            |                         |                     |                     |                |            |  |
| Maximum Power (Kw) / (rpm)                      | 120 / 3500   | 110 / 3500 | 120 / 3500          | 110 / 3500 | 120 / 3500          | 110 / 3500 | 110 / 3500              | 120 / 3500          | 110 / 3500          | 120 / 3500     | 110 / 3500 |  |
| Maximum Torque (nM) / (rpm)                     | 360 / 1500   | 350 / 1500 | 360 / 1500          | 350 / 1500 | 360 / 1500          | 350 / 1500 | 350 / 1500              | 360 / 1500          | 350 / 1500          | 360 / 1500     | 350 / 1500 |  |
| <b>TRANSMISSION</b>                             |  |            |                     |            |                     |            |                         |                     |                     |                |            |  |
| Type  | 6 Speed Manual / 6 Speed Automated Manual          |            |                     |            |                     |            |                         |                     |                     |                |            |  |
| Driven Wheels                                   | Front  |            |                     |            |                     |            |                         | Rear                |                     |                |            |  |
| Speeds at 1000 rpm in:                          | 1st gear   |            | 6.75                |            | 5.93                |            |                         |                     |                     |                |            |  |
|   | 2nd gear   |            | 12.64               |            | 11.5                |            |                         |                     |                     |                |            |  |
|   | 3rd gear   |            | 20.36               |            | 17.1                |            |                         |                     |                     |                |            |  |
|   | 4th gear   |            | 28.95               |            | 23.36               |            |                         |                     |                     |                |            |  |
|   | 5th gear   |            | 37.36               |            | 30.55               |            |                         |                     |                     |                |            |  |
|   | 6th gear   |            | 40.34               |            | 38.22               |            |                         |                     |                     |                |            |  |
| <b>STEERING &amp; BRAKES</b>                    |  |            |                     |            |                     |            |                         |                     |                     |                |            |  |
| Turning Circle (Kerb to Kerb)                   | 12   |            | 13.6                |            | 15.7                |            |                         |                     |                     |                |            |  |
| Turns lock-to-lock                              | 3.76   |            |                     |            |                     |            |                         |                     |                     |                |            |  |
| Brakes (Front)                                  | 302 x 28 Disc                                      |            |                     |            |                     |            |                         |                     |                     |                |            |  |
| Brakes (Rear)                                   | 305 x 12 Disc                                      |            |                     |            |                     |            |                         | 302 x 18 Disc       |                     |                |            |  |
| <b>WHEELS &amp; TYRES</b>                       |  |            |                     |            |                     |            |                         |                     |                     |                |            |  |
| Wheels (Front)                                  | 6.5 J16  |            |                     |            |                     |            |                         | 5.5 J16             |                     |                |            |  |
| Wheels (Rear)                                   |  |            |                     |            |                     |            |                         |                     |                     |                |            |  |
| Tyres (Front)                                   | 225/65 R16 (Single)                                |            |                     |            |                     |            |                         | 195/75 R16 (Single) |                     |                |            |  |
| Tyres (Rear)                                    | 195/75 R16 (Dual)                                  |            |                     |            |                     |            |                         |                     |                     |                |            |  |
| <b>CAPACITY</b>                                 |  |            |                     |            |                     |            |                         |                     |                     |                |            |  |
| Fuel Tank (litres)                              | 100  |            |                     |            |                     |            |                         |                     |                     |                |            |  |
| <b>WEIGHTS (kg)</b>                             |  |            |                     |            |                     |            |                         |                     |                     |                |            |  |
| Kerb Weight                                     | 1816   |            | 1927                |            | 1970                |            | 2020                    |                     | 2288                |                | 2366       |  |
| Gross Vehicle Mass                              | 3510   |            | 3890                |            | 4495                |            |                         |                     |                     |                |            |  |
| Payload   | 1694   |            | 1583                |            | 1540                |            | 1870                    |                     | 2207                |                | 2129       |  |
| Front Axle Load                                 | 1850   |            |                     |            |                     |            |                         |                     |                     |                |            |  |
| Rear Axle Load                                  | 2100   |            |                     |            |                     |            |                         | 3200                |                     |                |            |  |
| Towing Weight, Braked                           | 2500   |            |                     |            |                     |            |                         | 3000                |                     |                |            |  |
| Towing Weight, Unbraked                         | 750  |            |                     |            |                     |            |                         |                     |                     |                |            |  |
| <b>DIMENSIONS (mm)</b>                          |  |            |                     |            |                     |            |                         |                     |                     |                |            |  |
| Wheelbase                                       | 3182   |            | 3682                |            | 4332                |            |                         |                     |                     |                |            |  |
| Overall Height, unladen (Max.)                  | 2307   |            | 2499                |            | 2488                |            | 2549                    |                     | 2808                |                |            |  |
| Overall Width (excluding Standard Door Mirrors) | 2070   |            |                     |            |                     |            |                         |                     |                     |                |            |  |
| Overall Width (including Standard Door Mirrors) | 2470   |            |                     |            |                     |            |                         |                     |                     |                |            |  |
| Overall Length                                  | 5048   |            | 5548                |            | 6198                |            | 6848                    |                     |                     |                |            |  |
| Front Track                                     | 1750   |            |                     |            |                     |            |                         |                     |                     |                |            |  |
| Rear Track                                      | 1730   |            |                     |            |                     |            |                         | 1612                |                     |                |            |  |
| Front Overhang                                  | 842  |            |                     |            |                     |            |                         |                     |                     |                |            |  |
| Rear Overhang                                   | 1024   |            |                     |            |                     |            |                         | 1674                |                     |                |            |  |
| Minimum Ground Clearance                        | 186  |            | 178                 |            | 172                 |            | 181                     |                     | 167                 |                |            |  |
| Cargo Bay Length (Max.)                         | 2583   |            | 3083                |            | 3733                |            | 4383                    |                     |                     |                |            |  |
| Cargo Bay Width (Max.)                          | 1765   |            |                     |            |                     |            |                         |                     |                     |                |            |  |
| Cargo Bay Width Between Wheel Arches (Max.)     | 1380   |            |                     |            |                     |            |                         | 1080                |                     |                |            |  |
| Cargo Bay Height (Max.)                         | 1700   |            | 1894                |            | 1798                |            | 2048                    |                     |                     |                |            |  |
| Width of Sliding Door(s) (Max.)                 | 1050   |            |                     |            |                     |            |                         |                     |                     |                |            |  |
| Height of Sliding Door Opening(s) (Max.)        | 1581   |            | 1780                |            | 1684                |            |                         |                     |                     |                |            |  |
| Rear Door Width (Max.)                          | 1580   |            |                     |            |                     |            |                         |                     |                     |                |            |  |
| Rear Door Height (Max.)                         | 1627   |            |                     |            | 1820                |            |                         |                     | 1724                |                |            |  |
| Loading Sill Height (Laden/Unladen)             | Min: 550 / Max: 564                                |            | Min: 548 / Max: 562 |            | Min: 543 / Max: 557 |            | Min: 706 / Max: 724     |                     | Min: 700 / Max: 715 |                |            |  |
| <b>VOLUME m<sup>3</sup></b>                     |  |            |                     |            |                     |            |                         |                     |                     |                |            |  |
| Load Volume                                     | 8.0  |            | 10.8                |            | 13.0                |            | 12.4                    |                     | 17.0                |                |            |  |

# Product features

## RENAULT MASTER VAN

| MODEL   | Panel van |      |      |      |      |
|---|-----------|------|------|------|------|
|   | FWD       |      |      | RWD  |      |
|   | L1H1      | L2H2 | L3H2 | L3H2 | L4H3 |
| <b>SAFETY &amp; SECURITY</b>  |           |      |      |      |      |
| Driver and passenger front airbags  | ●         | ●    | ●    | ●    | ●    |
| Driver side airbag  | ●         | ●    | ●    | ●    | ●    |
| Passenger side airbag (Only available with single passenger seat)   | ○         | ○    | ○    | ○    | ○    |
| ABS (Anti-Lock Braking System) with EBD (Electronic Brake Force Distribution)   | ●         | ●    | ●    | ●    | ●    |
| ESC (Electronic Stability Control)  | ●         | ●    | ●    | ●    | ●    |
| Grip X-tend   | ●         | ●    | ●    | ●    | ●    |
| Hill Start Assist   | ●         | ●    | ●    | ●    | ●    |
| 3-point height adjustable front seat belts with pre-tensioner   | ●         | ●    | ●    | ●    | ●    |
| Remote central locking  | ●         | ●    | ●    | ●    | ●    |
| One touch door locking  | ●         | ●    | ●    | ●    | ●    |
| Hands-free key  | ○         | ○    | ○    | ○    | ○    |
| Renault Anti-Intruder Device (R.A.I.D) - automatic locking of doors while driving (activated once above 30km/h)                     | ●         | ●    | ●    | ●    | ●    |
| Alarm   | ○         | ○    | ○    | ○    | ○    |
| Engine immobiliser  | ●         | ●    | ●    | ●    | ●    |
| Double optic front headlamps  | ●         | ●    | ●    | ●    | ●    |
| Double optic front headlamps with cornering lamps   | ○         | ○    | ○    | ○    | ○    |
| Variable speed windscreen wipers  | ○         | ○    | ○    | ○    | ○    |
| Automatic headlights and rain sensing windscreen wipers (only available with front fog lights)                                      | ○         | ○    | ○    | ○    | ○    |
| Automatic headlights with High/low beam function and rain sensing windscreen wipers (only available with front fog lights)          | ○         | ○    | ○    | ○    | ○    |
| Lane departure warning  | ●         | ●    | ●    | ●    | ●    |
| Turn indicator lights on door mirrors with highway mode   | ○         | ○    | ○    | ○    | ○    |
| Front fog lights  | ●         | ●    | ●    | ●    | ●    |
| Rear fog lights   | ●         | ●    | ●    | ●    | ●    |
| Cruise control and speed limiter  | ●         | ●    | ●    | ●    | ●    |
| Brake pad wear indicator  | ●         | ●    | ●    | ●    | ●    |
| <b>INTERIOR</b>   |           |      |      |      |      |
| Height, reach, lumbar adjustable driver's seat with armrest   | ●         | ●    | ●    | ●    | ●    |
| Isringhausen® driver's suspension seat (Not available with driver side airbag)  | ○         | ○    | ○    | ○    | ○    |
| Dual passenger bench seat with fold down centre seat and integrated seat back table   | ●         | ●    | ●    | ●    | ●    |
| Storage compartment under passenger seat (N/a with Vinyl-look seat upholstery)  | ○         | ○    | ○    | ○    | ○    |
| Height, reach, lumbar adjustable single passenger seat  | ○         | ○    | ○    | ○    | ○    |
| 3 front headrests (2 height adjustable)   | ●         | ●    | ●    | ●    | ●    |
| Cloth seat upholstery   | ●         | ●    | ●    | ●    | ●    |
| Heavy Duty Low Maintenance (Vinyl-look) Seat Trim (N/a with storage compartment under passenger seat or driver's suspension seat)   | ○         | ○    | ○    | ○    | ○    |
| Premium dashboard with chrome insert  | ○         | ○    | ○    | ○    | ○    |
| Height adjustable steering column   | ●         | ●    | ●    | ●    | ●    |
| Power steering  | ●         | ●    | ●    | ●    | ●    |
| Passenger Wide view mirror  | ●         | ●    | ●    | ●    | ●    |
| Day/Night rear view mirror  | ●         | ●    | ●    | ●    | ●    |
| Manual air conditioning with pollen filter  | ●         | ●    | ●    | ●    | ●    |
| Climate controlled air conditioning with pollen filter (only available with automatic headlights, windscreen wipers and fog lights) | ○         | ○    | ○    | ○    | ○    |
| Electric front windows  | ●         | ●    | ●    | ●    | ●    |
| Overhead storage shelf  | ●         | ●    | ●    | ●    | ●    |
| Cup holders (dash x 2, console x 2, seat back x 2)  | ●         | ●    | ●    | ●    | ●    |
| Drink bottle door storage x2  | ●         | ●    | ●    | ●    | ●    |
| A4 dashboard storage compartment  | ○         | ○    | ○    | ○    | ○    |
| Closed glove box  | ●         | ●    | ●    | ●    | ●    |
| Rear window demister  | ●         | ●    | ●    | ●    | ●    |
| Smoking accessory (removable)   | ●         | ●    | ●    | ●    | ●    |
| Coat hooks x3   | ●         | ●    | ●    | ●    | ●    |
| Interior light  | ●         | ●    | ●    | ●    | ●    |
| Digital clock with outside air temperature display  | ●         | ●    | ●    | ●    | ●    |
| <b>TECHNOLOGY</b>   |           |      |      |      |      |
| Multifunction trip computer   | ●         | ●    | ●    | ●    | ●    |
| Automatic Start&Stop engine technology (programmable)*  | ●         | ●    | ●    | ●    | ●    |
| ECO Mode*   | ●         | ●    | ●    | ●    | ●    |
| ESM* (Energy Smart Management) with regenerative braking systems  | ●         | ●    | ●    | ●    | ●    |
| Gear change indicator   | ●         | ●    | ●    | ●    | ●    |
| 2x15W CD/MP3 Radio with steering mounted controls   | ●         | ●    | ●    | ●    | ●    |
| Bluetooth® hands-free connectivity with audio streaming   | ●         | ●    | ●    | ●    | ●    |
| 2x USB audio inputs and 3.5mm AUX jack (Only 1 USB with optional MediaNav)  | ●         | ●    | ●    | ●    | ●    |
| 12V dashboard power outlet  | ●         | ●    | ●    | ●    | ●    |
| 180A alternator   | ●         | ●    | ●    | ●    | ●    |
| Reverse parking sensors   | ●         | ●    | ●    | ●    | ●    |
| Reversing camera  | ●         | ●    | ●    | ●    | ●    |
| MediaNav audio and navigation system with 7" touchscreen  | ○         | ○    | ○    | ○    | ○    |

# RENAULT MASTER VAN

| MODEL   | Panel van |      |      |      |      |
|---|-----------|------|------|------|------|
|   | FWD       |      |      | RWD  |      |
|   | L1H1      | L2H2 | L3H2 | L3H2 | L4H3 |
| <b>EXTERIOR</b>   |           |      |      |      |      |
| Small wheel covers  | ●         | ●    | ●    | ●    | ●    |
| Full wheel covers   | ○         | ○    | ○    | -    | -    |
| Under body spare wheel  | ●         | ●    | ●    | ●    | ●    |
| Front and rear mud flaps  | ●         | ●    | ●    | ●    | ●    |
| Protective body side mouldings  | ●         | ●    | ●    | ●    | ●    |
| Front bumper with integrated step   | ●         | ●    | ●    | ●    | ●    |
| Electric adjustable door mirrors with wide angle blind spot                             | ●         | ●    | ●    | ●    | ●    |
| Left sliding door - unglazed  | ●         | ●    | ●    | ●    | ●    |
| Right panel - unglazed  | ●         | ●    | ●    | ●    | ●    |
| Left sliding door - glazed and right panel - glazed                                     | ○         | ○    | ○    | ○    | ○    |
| Left sliding door - opening window and right panel - opening window                     | -         | -    | -    | -    | -    |
| Left and right sliding doors - unglazed   | ○         | ○    | ○    | ○    | ○    |
| Left and right sliding doors - glazed   | ○         | ○    | ○    | ○    | ○    |
| Left and right sliding doors - opening window   | ○         | ○    | ○    | ○    | ○    |
| Rear side panel - glazed (only available with glazed or opening windows)                | ○         | ○    | ○    | ○    | ○    |
| Dual rear doors with 180 degree opening - glazed  | ●         | -    | -    | -    | -    |
| Dual rear doors with 180 degree opening - unglazed                                      | ○         | -    | -    | -    | -    |
| Dual rear doors with 270 degree opening - glazed  | -         | ●    | ●    | ●    | ●    |
| Dual rear doors with 270 degree opening - unglazed                                      | -         | ○    | ○    | ○    | ○    |
| Eaton® automatic differential lock  | -         | -    | -    | ○    | ○    |
| <b>CARGO</b>  |           |      |      |      |      |
| Full steel bulkhead - glazed  | ●         | ●    | ●    | ●    | ●    |
| No bulkhead   | -         | -    | -    | -    | -    |
| Cargo tie downs   | ●         | ●    | ●    | ●    | ●    |
| 12V power outlet  | ●         | ●    | ●    | ●    | ●    |
| 2x Interior cargo area lighting   | ●         | ●    | ●    | ●    | ●    |
| Mid-height cargo area lining  | ●         | ●    | ●    | ●    | ●    |
| Mid-height plywood cargo area lining  | -         | ○    | ○    | ○    | ○    |
| Anti-slip timber floor  | ○         | ○    | ○    | ○    | ○    |
| Anti-slip timber floor and plywood cargo area lining (N/a with any glazed sliding door) | ○         | ○    | ○    | ○    | ○    |
| <b>WARRANTY</b>   |           |      |      |      |      |
| 3 Year / unlimited Kilometres with 24 Hour Roadside Assistance                          | ●         | ●    | ●    | ●    | ●    |

\* Manual transmission only

● = Standard, ○ = Factory Option, - = Not Available

# Cab Chassis Colours



Glacier White (389) S



Pearlescent Black (676) M



Orange (031) S



Star Grey (KNH) M

# Technical Specifications

## RENAULT MASTER CAB CHASSIS

| MODEL        | Single Cab Chassis |         | Dual Cab Chassis |         | Platform Cab Chassis |         |
|--------------|--------------------|---------|------------------|---------|----------------------|---------|
|              | L4H1 RWD           |         | L4H1 RWD         |         | L3H1 FWD             |         |
| Transmission | 165 MT             | 150 AMT | 165 MT           | 150 AMT | 165 MT               | 150 AMT |

### ENGINE

|                             |  |            |            |            |            |            |
|-----------------------------|--|------------|------------|------------|------------|------------|
| Type                        | Turbocharged & Intercooled Direct Injection Diesel |            |            |            |            |            |
| Emission Standard           | Euro 5   |            |            |            |            |            |
| Capacity (cc)               | 2,299  |            |            |            |            |            |
| Bore x Stroke               | 85 x 101.3   |            |            |            |            |            |
| Cylinders / Valves          | 4 / 16   |            |            |            |            |            |
| Maximum Power (kW) / (rpm)  | 120 / 3500   | 110 / 3500 | 120 / 3500 | 110 / 3500 | 120 / 3500 | 110 / 3500 |
| Maximum Torque (Nm) / (rpm) | 360 / 1500   | 350 / 1500 | 360 / 1500 | 350 / 1500 | 360 / 1500 | 350 / 1500 |

### TRANSMISSION

|                        |   |      |  |  |       |      |
|------------------------|---|------|--|--|-------|------|
| Type                   | 6 Speed Manual / 6 Speed Automated Manual |      |  |  |       |      |
| Driven Wheels          | Rear                                      |      |  |  | Front |      |
| Speeds at 1000 rpm in: | 1st gear                                  | 5.9  |  |  |       | 6.7  |
|                        | 2nd gear                                  | 11.5 |  |  |       | 12.6 |
|                        | 3rd gear                                  | 17.1 |  |  |       | 20.3 |
|                        | 4th gear                                  | 23.4 |  |  |       | 28.9 |
|                        | 5th gear                                  | 30.6 |  |  |       | 37.3 |
|                        | 6th gear                                  | 38.2 |  |  |       | 40.3 |

### STEERING & BRAKES

|                               |               |  |  |               |  |  |
|-------------------------------|---------------|--|--|---------------|--|--|
| Turning Circle (Kerb to Kerb) | 15.7          |  |  |               |  |  |
| Turns lock-to-lock            | 3.76          |  |  |               |  |  |
| Brakes (Front)                | 302 x 28 Disc |  |  |               |  |  |
| Brakes (Rear)                 | 302 x 18 Disc |  |  | 305 x 12 Disc |  |  |

### WHEELS & TYRES

|                         |                     |  |  |  |                     |  |
|-------------------------|---------------------|--|--|--|---------------------|--|
| Wheels (Front and rear) | 5.5 J16             |  |  |  | 6.5 J16             |  |
| Tyres (Front)           | 195/75 R16 (Single) |  |  |  | 225/65 R16 (Single) |  |
| Tyres (Rear)            | 195/75 R16 (Dual)   |  |  |  | 225/65 R16 (Single) |  |

### CAPACITY

|                    |     |  |  |  |  |  |
|--------------------|-----|--|--|--|--|--|
| Fuel Tank (litres) | 100 |  |  |  |  |  |
|--------------------|-----|--|--|--|--|--|

### WEIGHTS (kg)

|                         |      |      |      |      |  |
|-------------------------|------|------|------|------|--|
| Kerb Weight             | 2005 | 2223 |      | 1600 |  |
| Gross Vehicle Mass      | 4495 |      | 3510 |      |  |
| Payload                 | 2490 | 2272 |      | 1910 |  |
| Front Axle Load         | 1850 |      |      |      |  |
| Rear Axle Load          | 3200 |      |      | 2100 |  |
| Towing Weight, Braked   | 3000 |      |      | 2500 |  |
| Towing Weight, Unbraked | 750  |      |      |      |  |

### DIMENSIONS (mm)

|  |             |      |  |      |  |
|--|-------------|------|--|------|--|
| Wheelbase  | 4332        |      |  |      |  |
| Overall Height unladen (Max.)                            | 2273        | 2286 |  | 2273 |  |
| Overall Width (excluding Standard Door Mirrors)          | 2070        |      |  |      |  |
| Overall Width (including Standard Door Mirrors)          | 2470        |      |  |      |  |
| Overall Length   | 6843        |      |  | 6180 |  |
| Front track  | 1750        |      |  |      |  |
| Rear track   | 1612        |      |  | 1730 |  |
| Front Overhang   | 842         |      |  |      |  |
| Rear Overhang  | 1575        |      |  | 1006 |  |
| Buildable Cargo Length                                   | 5470        | 4436 |  | 4583 |  |
| Buildable Cargo Width (Standard / Extended Door Mirrors) | 2170 / 2350 |      |  |      |  |
| Height of Bare Chassis                                   | 786         | 778  |  | 579  |  |

\*Unladen, will change depending on equipment fitted

# Product features

## RENAULT MASTER CAB CHASSIS

| MODEL   | Single Cab Chassis | Dual Cab Chassis | Platform Cab Chassis |
|---|--------------------|------------------|----------------------|
|   | L4H1 RWD           | L4H1 RWD         | L3H1 FWD             |
| <b>SAFETY &amp; SECURITY</b>  |                    |                  |                      |
| Driver and passenger front airbags  | ●                  | ●                | ●                    |
| Driver side airbag  | ●                  | ●                | ●                    |
| Passenger side airbag (Only available with single passenger seat)   | ○                  | ○                | ○                    |
| ABS (Anti-Lock Braking System) with EBD (Electronic Brake Force Distribution)   | ●                  | ●                | ●                    |
| ESC (Electronic Stability Control)  | ●                  | ●                | ●                    |
| Grip X-tend   | ●                  | ●                | ●                    |
| Hill Start Assist   | ●                  | ●                | ●                    |
| 3-point height adjustable front seat belts with pre-tensioner   | ●                  | ●                | ●                    |
| Rear 3-point seat belts on side seats with 2-point in middle seats  | -                  | ●                | -                    |
| Remote central locking  | ●                  | ●                | ●                    |
| One touch door locking  | ●                  | ●                | ●                    |
| Hands-free key  | ○                  | ○                | ○                    |
| Renault Anti-Intruder Device (R.A.I.D) - automatic locking of doors while driving (activated once above 30km/h)                     | ●                  | ●                | ●                    |
| Engine immobiliser  | ●                  | ●                | ●                    |
| Double optic front headlamps  | ●                  | ●                | ●                    |
| Double optic front headlamps with cornering lamps   | ○                  | ○                | ○                    |
| Variable speed windscreen wipers  | ●                  | ●                | ●                    |
| Automatic headlights and rain sensing windscreen wipers (only available with front fog lights)                                      | ○                  | ○                | ○                    |
| Turn indicator lights on door mirrors with highway mode   | ●                  | ●                | ●                    |
| Front fog lights  | ○                  | ○                | ○                    |
| Rear fog lights   | ●                  | ●                | ●                    |
| Cruise Control & Variable Speed Limiter   | ●                  | ●                | ●                    |
| Brake pad wear indicator  | ●                  | ●                | ●                    |
| <b>INTERIOR</b>   |                    |                  |                      |
| Height, reach, lumbar adjustable driver's seat with armrest   | ●                  | ●                | ●                    |
| Irringhausen® driver's suspension seat (N/a with Vinyl-look seat upholstery)  | ○                  | ○                | ○                    |
| Dual passenger bench seat with fold down centre seat and integrated seat back table   | ●                  | ●                | ●                    |
| Height, reach, lumbar adjustable single passenger seat  | ○                  | ○                | ○                    |
| Rear bench (four people seating capacity)   | -                  | ●                | -                    |
| 3 front headrests (2 height adjustable)   | ●                  | ●                | ●                    |
| Cloth seat upholstery   | ●                  | ●                | ●                    |
| Premium dashboard with chrome insert  | ○                  | ○                | ○                    |
| Height adjustable steering column   | ●                  | ●                | ●                    |
| Power steering  | ●                  | ●                | ●                    |
| Passenger Wide view mirror  | ●                  | ●                | ●                    |
| Day/Night rear view mirror  | ●                  | ●                | ●                    |
| Manual air conditioning with pollen filter  | ●                  | ●                | ●                    |
| Climate controlled air conditioning with pollen filter (Only available with automatic headlights, windscreen wipers and fog lights) | ○                  | ○                | ○                    |
| Electric front windows  | ●                  | ●                | ●                    |
| Opening rear side windows   | -                  | ●                | -                    |
| Overhead storage shelf  | ●                  | ●                | ●                    |
| Cup holders (dash x 2, console x 2, seat back x 2)  | ●                  | ●                | ●                    |
| Drink bottle door storage x2  | ●                  | ●                | ●                    |
| A4 dashboard storage compartment  | ○                  | ○                | ○                    |
| Closed glove box  | ●                  | ●                | ●                    |
| Smoking accessory (removable)   | ●                  | ●                | ●                    |
| Coat hooks  | ●                  | -                | ●                    |
| Interior light  | ●                  | ●                | ●                    |
| Digital clock with outside air temperature display  | ●                  | ●                | ●                    |

## RENAULT MASTER CAB CHASSIS

| MODEL   | Single Cab Chassis | Dual Cab Chassis | Platform Cab Chassis |
|---|--------------------|------------------|----------------------|
|   | L4H1 RWD           | L4H1 RWD         | L3H1 FWD             |
| <b>TECHNOLOGY</b>   |                    |                  |                      |
| Multifunction trip computer   | ●                  | ●                | ●                    |
| Automatic Start&Stop engine technology (programmable)*                            | ●                  | ●                | ●                    |
| ECO Mode*   | ●                  | ●                | ●                    |
| ESM* (Energy Smart Management) with regenerative braking systems                  | ●                  | ●                | ●                    |
| Gear change indicator   | ●                  | ●                | ●                    |
| 2x15W CD/MP3 Radio with steering mounted controls                                 | ●                  | ●                | ●                    |
| Bluetooth® hands-free connectivity with audio streaming                           | ●                  | ●                | ●                    |
| 2xUSB audio inputs and 3.5mm AUX jack (only 1 USB with medianav)                  | ●                  | ●                | ●                    |
| 12V dashboard power outlet  | ●                  | ●                | ●                    |
| 180A alternator   | ●                  | ●                | ●                    |
| MediaNav audio and navigation system with 7" touchscreen                          | ○                  | ○                | ○                    |
| <b>EXTERIOR</b>   |                    |                  |                      |
| Small wheel covers  | ●                  | ●                | ●                    |
| Under body spare wheel  | ●                  | ●                | ●                    |
| Front mud flaps   | ●                  | ●                | ●                    |
| Rear mud flaps  | -                  | -                | ●                    |
| Protective side body mouldings  | ●                  | ●                | ●                    |
| Front bumper with integrated step   | ●                  | ●                | ●                    |
| Electric door mirrors with wide angle blind spot mirrors                          | ●                  | ●                | ●                    |
| Extended arms electric adjustable door mirrors with wide angle blind spot mirrors | ○                  | ○                | ○                    |
| Eaton® automatic differential lock  | ○                  | ○                | -                    |
| <b>CARGO</b>  |                    |                  |                      |
| Steel bulkhead - glazed   | ●                  | ●                | ●                    |
| Aluminium tray with tool box and ladder support                                   | ○                  | ○                | -                    |
| <b>OPTION PACKS</b>   |                    |                  |                      |
| <b>Business Pack</b>  |                    |                  |                      |
| Automatic Double Optic Head Lights with Cornering Function                        | ○                  | ○                | ○                    |
| Automatic Windshield Wipers   | ○                  | ○                | ○                    |
| Lane Departure Warning  | ○                  | ○                | ○                    |
| Premium Look Dash With Chrome Inserts   | ○                  | ○                | ○                    |
| Front Fog Lights  | ○                  | ○                | ○                    |
| Automatic Climate Control Air Conditioning  | ○                  | ○                | ○                    |
| Closed A4 Dash Storage Compartment  | ○                  | ○                | ○                    |
| Hands-Free Entry System   | ○                  | ○                | ○                    |
| In-Dash MediaNav Audio & Navigation System with 7" Touch Screen                   | ○                  | ○                | ○                    |
| <b>WARRANTY</b>   |                    |                  |                      |
| 3 Year / 200,000 Kilometres with 24 Hour Roadside Assistance                      | ●                  | ●                | ●                    |

\* Manual transmission only

● = Standard, ○ = Factory Option, - = Not Available

# Layout Diagrams

## Vans

There's no such thing as a "one-size-fits-all" van, and that's why Master comes with cargo volumes of 8 to 17 cubic meters, front or rear wheel drive powertrains and payloads of 1.6 to 2.2 tonnes.



Front-wheel drive panel van



Rear-wheel drive panel van

## Cab Chassis

Single and Dual Cab/Chassis models are available with a 4.2M tray featuring a powder coated steel frame, alloy drop sides, adjustable rear ladder rack, integrated mudguards and toolbox, and even a handy flip out step.



Platform Cab Chassis



Single Cab Chassis with optional factory tray



Dual Cab Chassis with optional factory tray

# Dimensions

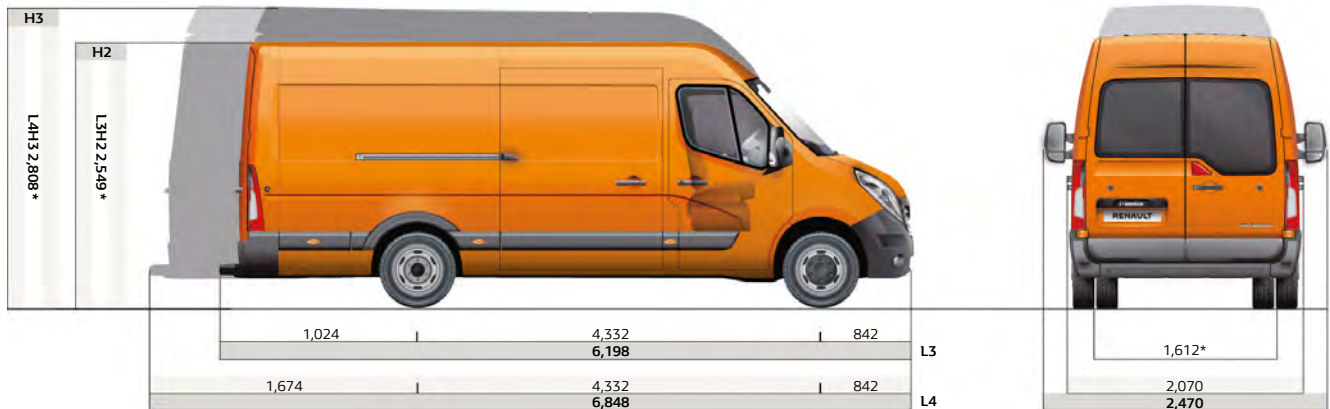

## Panel Van REAR-WHEEL DRIVE

| MODEL        | LWB<br>Mid Roof | ELWB<br>High Roof |
|--------------|-----------------|-------------------|
|              | L3H2 RWD        | L4H3 RWD          |
| Transmission | 165 MT          | 165 MT            |

### DIMENSIONS (mm)

|   |                     |                     |
|---|---------------------|---------------------|
| Wheelbase                                       | 4332                |                     |
| Overall Height (unladen)                        | 2549                | 2808                |
| Overall Width (excluding Standard Door Mirrors) | 2070                |                     |
| Overall Width (including Standard Door Mirrors) | 2470                |                     |
| Overall Length                                  | 6198                | 6848                |
| Cargo Bay Length (Max.)                         | 3733                | 4383                |
| Cargo Bay Width (Max.)                          | 1765                |                     |
| Cargo Bay Height (Max.)                         | 1894                | 2048                |
| Cargo Bay Width Between Wheel Arches (Max.)     | 1080                |                     |
| Front Overhang                                  | 842                 |                     |
| Rear Overhang                                   | 1024                | 1674                |
| Front Track                                     | 1750                |                     |
| Rear Track                                      | 1612                |                     |
| Width of Sliding Door(s) (Max.)                 | 1270                |                     |
| Height of Sliding Door Opening(s) (Max.)        | 1684                |                     |
| Rear Door Width (Max.)                          | 1580                |                     |
| Rear Door Height (Max.)                         | 1724                |                     |
| Loading Sill Height (Laden/Unladen)             | Min: 706 / Max: 724 | Min: 700 / Max: 715 |
| Minimum Ground Clearance                        | 214                 |                     |



## Panel Van FRONT-WHEEL DRIVE

| MODEL   | SWB<br>Low Roof     | MWB<br>Mid Roof     | LWB<br>Mid Roof     |
|---|---------------------|---------------------|---------------------|
|   | L1H1 FWD            | L2H2 FWD            | L3H2 FWD            |
| Transmission                                    | 165 MT              | 165 MT              | 165 MT              |
| <b>DIMENSIONS (mm)</b>                          |                     |                     |                     |
| Wheelbase                                       | 3182                | 3682                | 4332                |
| Overall Height (unladen)                        | 2310                | 2499                | 2549                |
| Overall Width (excluding Standard Door Mirrors) | 2070                |                     |                     |
| Overall Width (including Standard Door Mirrors) | 2470                |                     |                     |
| Overall Length                                  | 5048                | 5548                | 6198                |
| Cargo Bay Length (Max.)                         | 2583                | 3083                | 3733                |
| Cargo Bay Width (Max.)                          | 1765                |                     |                     |
| Cargo Bay Height (Max.)                         | 1700                | 1894                |                     |
| Cargo Bay Width Between Wheel Arches (Max.)     | 1380                |                     |                     |
| Front Overhang                                  | 842                 |                     |                     |
| Rear Overhang                                   | 1024                |                     |                     |
| Front Track                                     | 1750                |                     |                     |
| Rear Track                                      | 1730                |                     |                     |
| Width of Sliding Door(s) (Max.)                 | 1050                | 1270                |                     |
| Height of Sliding Door Opening(s) (Max.)        | 1581                | 1780                |                     |
| Rear Door Width (Max.)                          | 1580                |                     |                     |
| Rear Door Height (Max.)                         | 1627                | 1820                |                     |
| Loading Sill Height (Laden/Unladen)             | Min: 546 / Max: 560 | Min: 550 / Max: 564 | Min: 543 / Max: 557 |
| Minimum Ground Clearance                        | 214                 |                     |                     |

\*Unladen, will change depending on equipment fitted

# Dimensions

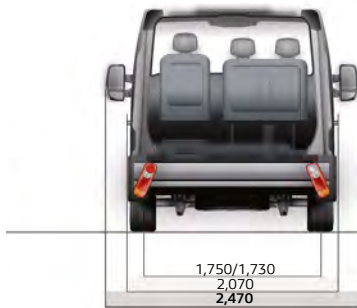
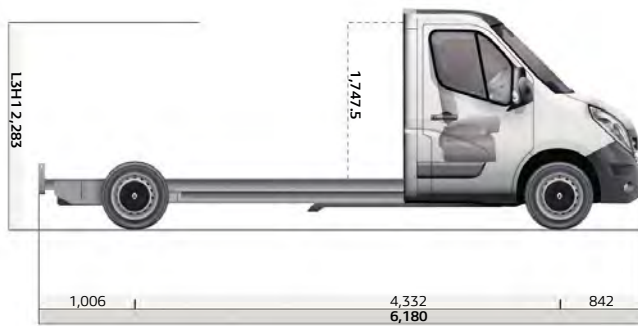

## Platform Cab Chassis

FRONT-WHEEL DRIVE

| MODEL  | Platform Cab Chassis |
|--|----------------------|
|  | L3H1 FWD             |
| Transmission   | 150 AMT              |
| <b>DIMENSIONS (mm)</b>                                     |                      |
| Wheelbase  | 4332                 |
| Overall Height (unladen)                                   | 2283                 |
| Overall Width (excluding Standard Door Mirrors)            | 2070                 |
| Overall Width (including Standard Door Mirrors)            | 2470                 |
| Overall Length   | 6180                 |
| Front Overhang   | 842                  |
| Rear Overhang  | 1006                 |
| Buildable Overall Length                                   | 7364                 |
| Buildable Overall Width (Standard / Extended Door Mirrors) | 2170 / 2350          |
| Height of Bare Chassis                                     | 579                  |
| Minimum ground clearance*                                  | 214                  |

\*Unladen, will change depending on equipment fitted

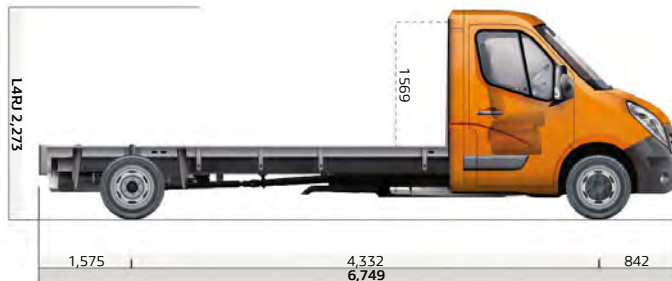

## Single Cab Chassis

REAR-WHEEL DRIVE

| MODEL  | Single Cab Chassis |
|--|--------------------|
|  | L4H1 RWD           |
| Transmission   | 165 MT             |
| <b>DIMENSIONS (mm)</b>                                     |                    |
| Wheelbase  | 4332               |
| Overall Height (unladen)                                   | 2273               |
| Overall Width (excluding Standard Door Mirrors)            | 2070               |
| Overall Width (including Standard Door Mirrors)            | 2470               |
| Overall Length   | 6749               |
| Front Overhang   | 842                |
| Rear Overhang  | 1575               |
| Buildable Overall Length                                   | 7928               |
| Buildable Overall Width (Standard / Extended Door Mirrors) | 2170 / 2350        |
| Height of Bare Chassis                                     | 786                |
| Minimum ground clearance*                                  | 214                |

\*Unladen, will change depending on equipment fitted

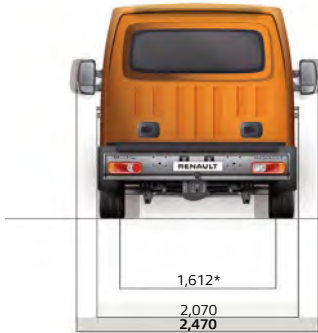
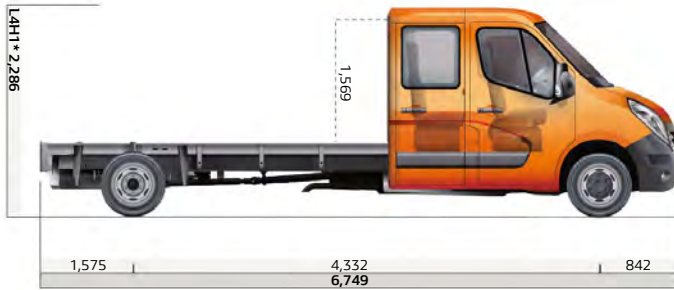

## Dual Cab Chassis

### REAR-WHEEL DRIVE

| MODEL  | Dual Cab Chassis |
|--|------------------|
|  | L4H1 RWD         |
| Transmission   | 165 MT           |
| <b>DIMENSIONS (mm)</b>                                     |                  |
| Wheelbase  | 4332             |
| Overall Height (unladen)                                   | 2286             |
| Overall Width (excluding Standard Door Mirrors)            | 2070             |
| Overall Width (including Standard Door Mirrors)            | 2470             |
| Overall Length   | 6749             |
| Front Overhang   | 842              |
| Rear Overhang  | 1575             |
| Buildable Overall Length                                   | 7928             |
| Buildable Overall Width (Standard / Extended Door Mirrors) | 2170 / 2350      |
| Height of Bare Chassis                                     | 778              |
| Minimum ground clearance*                                  | 214              |

\*Unladen, will change depending on equipment fitted

# Genuine Accessories

## Towing and Payload

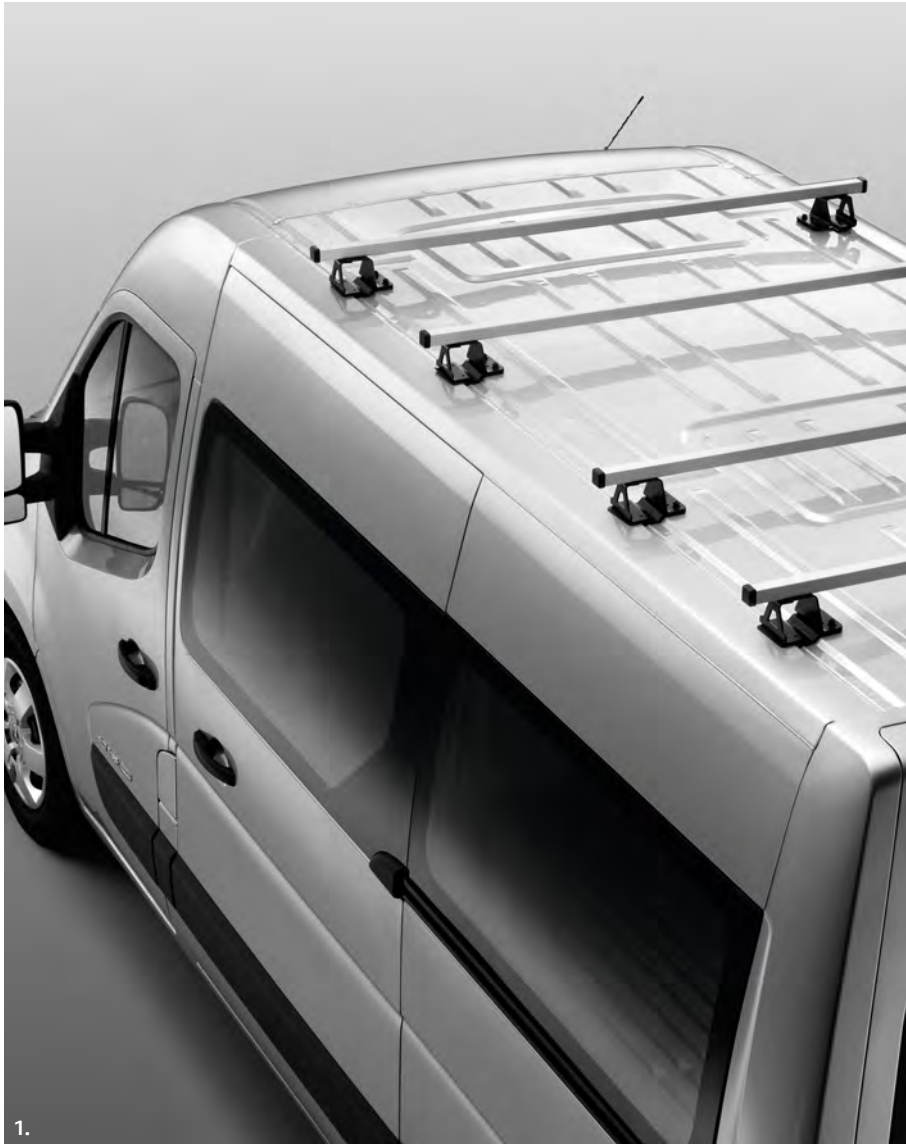

For your towing and transport needs, the range of Renault Genuine Accessories for Master Van – sourced from both Europe and locally here in Australia – have you covered.

Examples include: **1. Roof bars** H1 (pair) - (7711427804) H2 (pair) - (7711425820) **2. Roof rack (pictured with walkway)** L1H2 - (7711425821) L2H2 - (7711425823) L3H2 - (7711425824) **Roof rack walkway** L1H2 - (8201159475) L2H2 - (7711425829) L3H2 - (7711425830) **3. Loading ladder** H1 - (7711425826) H2 - (7711425827) For Towbars and the full range of accessories go to [renault.com.au](http://renault.com.au)

# Genuine Accessories

## Storage and Cargo



Master Van means business. If you're in the business of moving cargo, our extensive range provides a guarantee to get you and your payload from A to B.

**1. Wooden lining** Go to [renault.com.au](https://www.renault.com.au) for options and part numbers for your model **2. Loading sill protection** (7711238315) **3. Aluminum conduit carrier** Go to [renault.com.au](https://www.renault.com.au) for options and part numbers for your model. **Rubber cargo mats** are also available in the full range of accessories, go to [renault.com.au](https://www.renault.com.au) to take a look.

# Genuine Accessories

## Comfort



1.



2.

3.



With a few simple additions, Renault Genuine Accessories can help make your mobile workplace even more comfortable.

**1. Smartphone support** (7711574875) **2. Carpet floor mats - front** (7711427552) Rubber floor mats - front also available (G4902X6200AU)  
**3. Reverse camera - sunvisor** (8201442773) Tablet supports, parking sensors, air conditioning curtain, and more are also available in the full range of accessories. Go to [renault.com.au](http://renault.com.au) to view the full range.

# Genuine Accessories

## Protection

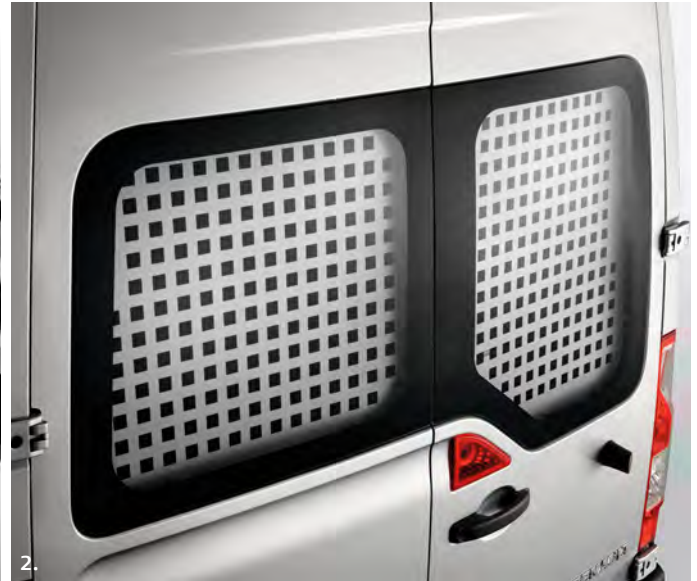

A little bit of protection for your vehicle goes a long way - especially when its time for resale. Choose Renault Genuine Accessories to protect your Master.

**1 & 2. Security mesh** LH sliding door (7711427964) RH sliding door (7711426013) H2 & H3 rear door (7711427945) **3. Safety & first aid kit** (7711425749) **4. Alarm** (7711425926) There's more protection accessories available, view the range at [renault.com.au](http://renault.com.au)

# Renault Pro+



## Service + Expertise + Convenience

**Renault Pro+ Dealer** staff are dedicated to providing you with the highest level of personal service to help you find the best vehicle solution for your business.

They have specialist training and are enthusiastic about using their expert knowledge of the Renault commercial range to find the vehicle that is right for you at an affordable price.

Pro+ Dealers provide a wide range of extra services to business customers to keep you mobile and productive. When you visit a Renault Pro+ Dealer you can expect service that is designed to let you focus on your No.1 priority – your business.

# The specialised Renault Pro+ network



Overseas model shown

**Pro+ Dealers have to meet extra standards to be eligible to become commercial vehicle specialists within the Renault network.**

**DISCOVER MORE** >

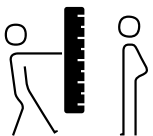

## **Specialists at your service**

Highly trained salespeople and service advisors with the extra skills required to sell and service commercial vehicles.

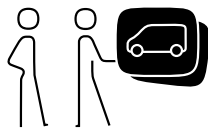

## **Decisions made easier**

With more vehicles available, including conversions, choosing the right vehicle for your business is easy at a Renault Pro+ Dealer.

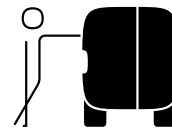

## **Your mobility guaranteed**

A range of extra services to keep you mobile - extended workshop hours, on-site pick up and delivery, free service loan vehicles and more.

# Our quality. Your peace of mind.

When you choose a Renault Commercial Vehicle, you can look forward to years of productive and economical service, backed by a trusted and reliable brand.

## **Comprehensive Warranty**

With over 100 years of Commercial Vehicle history, our experience is reflected in the design, performance and quality of every vehicle we sell. We're so confident of the quality in your new Renault Kangoo, we back it with a 3 year, unlimited km warranty.

## **24/7 Roadside Assistance**

As a new Renault owner, you are backed by Renault's 24/7 Roadside Assistance for the length of your warranty when you service your vehicle with Renault, regardless of how many kilometres you travel. Simply call 1800 009 008 and we'll provide the support you need. Available 24/7, 365 day a year, all across Australia.

## **Servicing**

For easy budgeting, enjoy Capped Price Services for the first 3 scheduled maintenance services. Plus, to minimise disruption to your business, authorised Renault dealers also have low-cost loan vehicles available to use. Authorised Renault Dealers have Registered Renault Factory Trained Technicians (COTECHs) and only use genuine Renault parts, equipment and tools specially designed for your Renault. There is also a 1 year parts and labour guarantee on all repairs. With a clear, simple and transparent pricing structure for all servicing, Renault provide reassurance, when you need it most.

TAKE A CLOSER LOOK







FIND A DEALER



For more information  
visit [renault.com.au](http://renault.com.au)

For more information call 1800 009 008 or visit [www.renault.com.au](http://www.renault.com.au). Details at November 2018 and subject to change. Vehicles displayed in this brochure are overseas models and shown for illustration purposes only. Australian vehicles may differ in characteristics, specifications, equipment, accessories and colours than shown in this brochure. Please see your Renault dealer for full specification and vehicle option queries. Vehicle Distributors Australia Pty Ltd reserve the right to modify its models without notice including their characteristics, specifications, equipment, accessories and colours. Publication date November 2018. Vehicle Distributors Australia Pty Ltd, Level 4, 10 Nexus Court, Mulgrave, Victoria 3170.

Renault recommends 

   [renault.com.au](http://renault.com.au)